



TITAN[®]

ACCESSORIES



SCAN FOR
DIGITAL COPY





THE BEST AND LONGEST WARRANTY IN THE INDUSTRY

Four-Year Manufacturer's Defect

We pledge that our sprayers are free from defects in materials and workmanship. This excludes normal wear items and consumables such as filters, piston, packings, spray tips, spray guns, hoses, etc.

Lifetime DuraLife™ HE Brushless and PMDC Motor Warranty

If the motor fails for any reason (including wear) for as long as you own the sprayer, we will replace the motor at no cost to you.

Limited Lifetime DCX Motor Warranty

If the motor fails from normal usage for as long as you own the sprayer, we will replace the motor at no cost to you.

Gas Engine Warranty

3-year Honda® and 2-years all others.

Two-Year Turbine Warranty

Lifetime Drive Train Warranty

If the drive train fails from normal usage for as long as you own the sprayer, we will replace the drive train at no cost to you.

Lifetime Warranty on PermaStroke Technology™ Fluid Pump

Get a lifetime warranty on the PermaStroke Technology fluid pump. If the fluid pump fails for any reason (including wear) for as long as you own the sprayer, we will replace the fluid pump at no cost to you.

35-Day Satisfaction Guarantee

If for any reason the sprayer does not perform up to your expectations within 35 days, the sprayer can be exchanged for the identical model or full credit toward the purchase of a Titan sprayer of larger size and value.

Express Parts Program

- ▶ More than 550 Authorized Service Centers nationwide
- ▶ The most common repair parts are guaranteed to be in stock 100% of the time
- ▶ If for any reason your preferred Authorized Service Center is out of stock, free 2nd day air is available when ordered by 3:00 pm (EST)

GO TO TITANWEARGUARD.COM FOR MORE INFORMATION.



TITAN®

ACCESSORIES

04 AIRLESS GUNS

An industry leader in spray gun technology – Titan offers a full line of the best quality airless guns for every application imaginable.

07 AIRLESS TIPS

Titan offers a full range of spray tips for a full range of applications.

12 GUN ACCESSORIES

Titan has a guard for every tip and the best paint filters available. And if your arms just aren't long enough we have a reach tool or gun extension.

16 AIRLESS HOSES

Designed to withstand time and pressure, Titan's full line of airless hoses will have you covered for every job.

18 ROLLERS

Our rollers have the speed of a sprayer and the control of a roller.

20 FITTINGS

Need more hose length or need to alter the angle of the hose connected to the sprayer? You need Titan manifolds and fittings.

22 LINE STRIPING ACCESSORIES

Check out our hard-working assortment of accessories devoted specifically to pavement and field marking.

24 HVLP GUNS & ACCESSORIES

For contractors and finishing professionals who expect flawless results, we have the tools for the perfect finish.

27 CLEANERS & LUBRICANTS

Titan has all the products you need to keep your equipment/accessories clean and functioning in top condition.



OUR MISSION

When your business depends on the tools you use, you need to be able to count on the people who make them.

Our relentless commitment to helping every professional painter be their best leads to better work, improved ROI and growing business.

RX-80™

AIRLESS SPRAY GUN

-  **Comfort Grip™**
Ergonomic design brings added comfort.
-  **Longer Life Packing Kit**
Lasts longer with improved performance.
-  **Onboard Tools**
Smart tools that make jobsite life easier.

- Comes with two or four-finger trigger
- Pressure rated at 3600 psi (24.8 MPa)

DESCRIPTION	PART NO.
RX-80 Airless Gun, Four-Finger with HEA Tip	538005
RX-80 Airless Gun, Two-Finger with HEA Tip	538006
RX-80 Airless Gun, Four-Finger with SC-6+	538007
RX-80 Airless Gun, Two-Finger with SC-6+	538008
RX-80 4-Finger Gun, Hose and Tip Kit with Tip*	2454979
RX-80 4-Finger Gun, Hose and Tip w/ SC-6+*	538011
RX-80 Gun, Hose and Tip Kit (8-pk)	2403960
RX-80 Repair Kit	538215



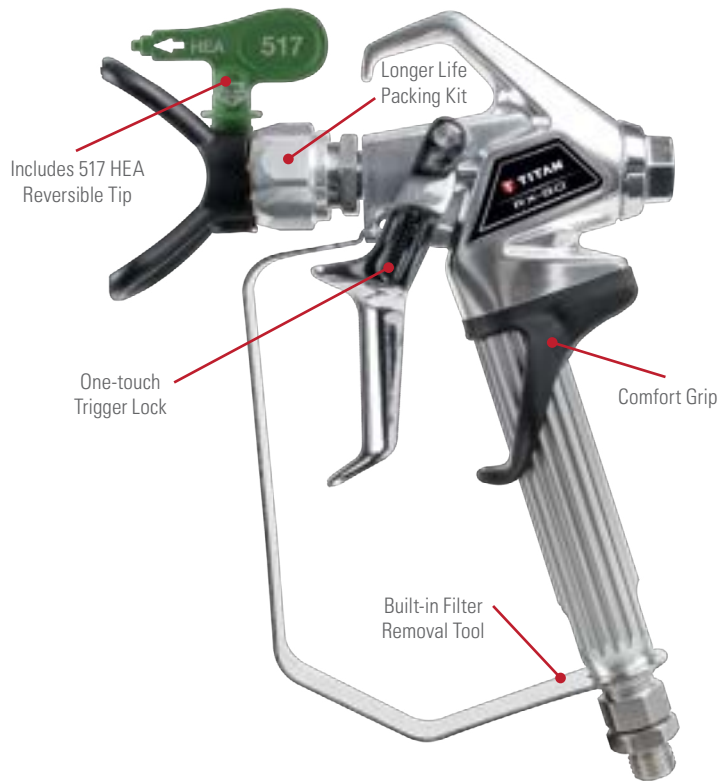

*Includes additional 3' whip hose and a 2-finger trigger.



Filter Assembly

RX-PRO®

AIRLESS SPRAY GUN

-  **Ultra-light Trigger**
30% lighter than the competitors trigger pull decreasing fatigue.
-  **FingerPrint Grip®**
Customize the grip to comfortably fit any painter's hand.
-  **Infinity Packing®**
2X the gun life by reversing the seat and changing the ball.
-  **Onboard Tools**
Smart tools that make jobsite life easier.

- Comes with both two and four-finger trigger
- Pressure rated at 3600 psi (24.8 MPa)

DESCRIPTION	PART NO.
RX-Pro Airless Gun with HEA Tip	538020
RX-Pro Gun, Hose, Whip & Tip Kit	538022
RX-Pro Gun, Hose, Whip & HEA™ Tip Kit	538033
RX-Pro Gun, Hose & HEA™ Tip Kit (8-pack)	2431654
RX-Pro Ball Valve	538221
RX-Pro Seat	594-033
RX-Pro Packing Seal Assy.	0538204A



FingerPrint Grip



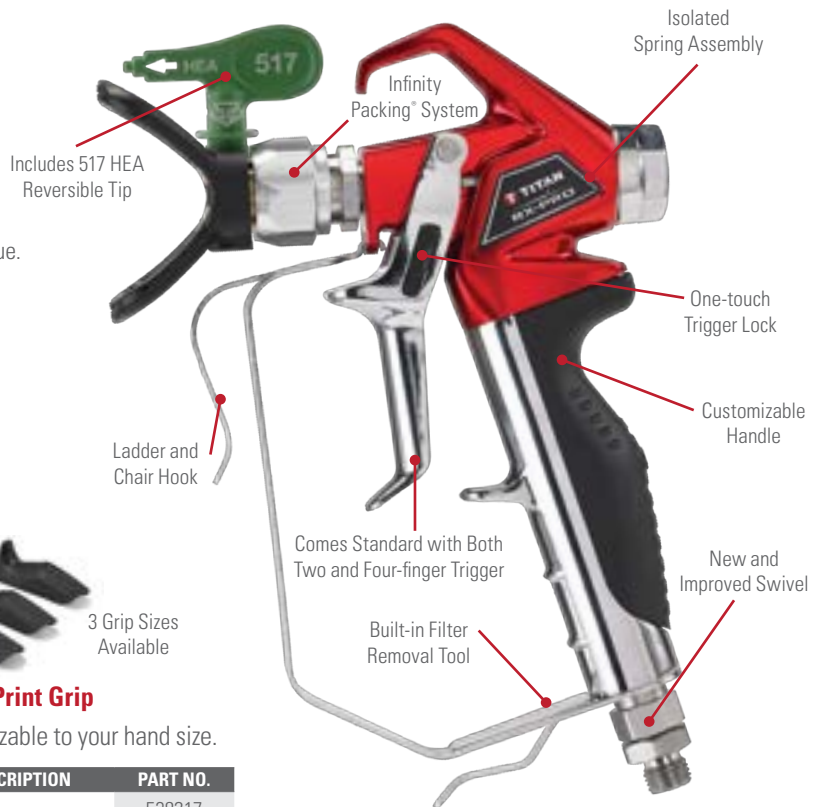

Customizable to your hand size.

DESCRIPTION	PART NO.
Small	538217
Medium	538218
Large	538219



RX-APEX™

AIRLESS SPRAY GUN

-  **All-Day Trigger®**
28% lighter trigger pull force and 74% less hold force.
-  **FingerPrint+ Grip™**
Fully adjustable grip delivers maximum customization.
-  **Infinity Packing**
2X the gun life by reversing the seat and changing the ball.
-  **Free-Flow Swivel**
Only direct feed airless gun with built-in swivel.

- Comes with two-finger trigger
- Pressure rated at 5000 psi (34.5 MPa)

DESCRIPTION	PART NO.
RX-Apex, Non-Filtered Airless Gun with Tip	538070
RX-Apex, Filtered Airless Gun with Tip	538075
RX-Apex, Non-Filtered Airless Gun, Hose & Tip Kit	538072
RX-Apex, Non-Filtered, High Pressure Airless Gun, Hose & Tip Kit	538073
RX-Apex, Filtered Airless Gun, Hose & Tip Kit	538076
RX-Apex, Filtered Airless Gun, Hose & HEA Tip Kit	538077



FingerPrint+ Grip
Customizable to your hand size.

DESCRIPTION	PART NO.
Small	538247
Medium	538248
Full	538256

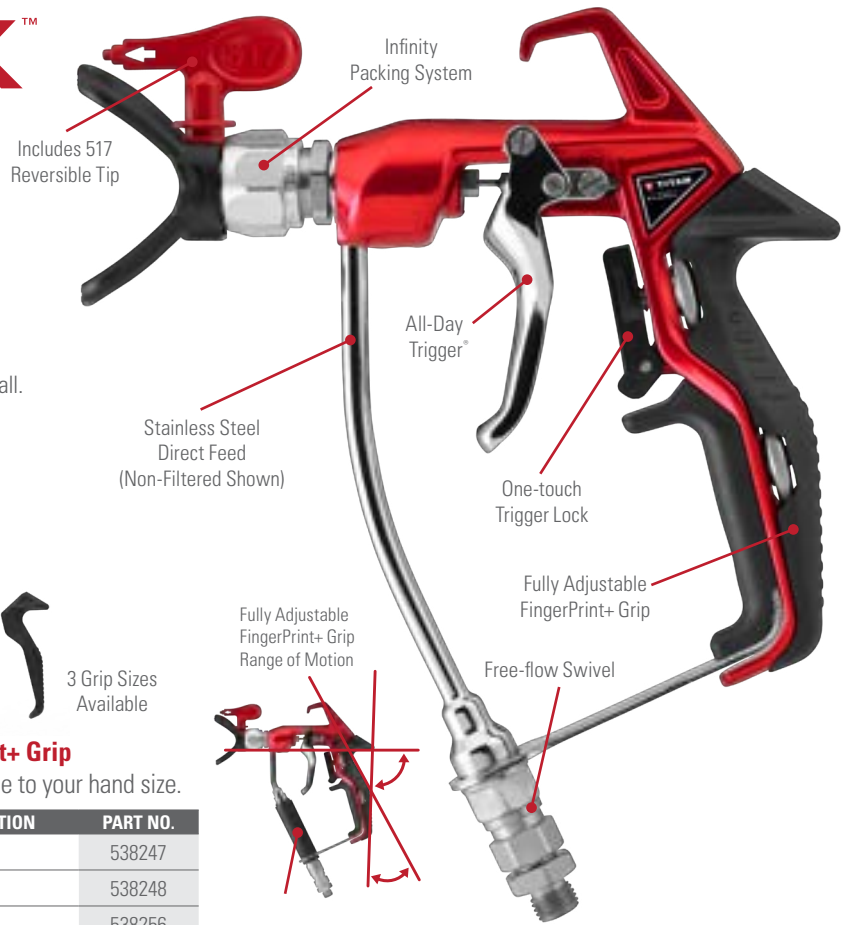

S-Series: Spray Specialized Coatings with Ease

S-3 Airless Gun

- In-handle filter
- Easy four-finger trigger pull
- 1/4" swivel reduces hose kinks
- Pressure rated at 3900 psi (26.9 MPa)



DESCRIPTION	PART NO.
S-3 Gun with Tip	550-250
S-3 Gun, Hose and Tip Kit	550065
S-3 Repair Kit	550-275

S-7 Airless Gun

- In-handle filter
- Available in two swivel sizes
- Easy four-finger trigger pull
- Swivel reduces hose kinks
- Includes 517 high pressure, heavy-duty reversible tip and guard
- Pressure rated at 7700 psi (53.1 MPa)



DESCRIPTION	PART NO.
S-7 Gun with 1/4" Swivel	550-260
S-7 Gun with 3/8" Swivel	550-270
S-7 Repair Kit	550-276

Entry Level Contractor Airless Guns

LX-40 Airless Gun 550-540

- All metal construction
- In-handle filter
- Tungsten carbide ball valve ensures long life
- Includes 517 reversible tip
- Pressure rated at 3000 psi (20.7 MPa)



FROM FINE FINISHING TO THE HARSHTEST COATINGS

From the harshest coatings (Mastic Guns) to detailed fine finish work (GM 3600 Pro Guns) Titan has a gun that fits your needs.



GM 3600 Pro Gun

M-4 Mastic Gun

GM 3600 Pro Gun

This air-assisted airless gun works with both standard reversible tips and Brilliant™ Flat Tips. It offers ergonomic comfort and a reversible tip system without sacrificing finish quality.

- ◆ Inline filter for clean coatings
- ◆ Stainless steel fluid passages
- ◆ Pressure rated at 3600 psi (24.8 MPa)

DESCRIPTION	PART NO.
GM 3600 AirCoat Gun with Reversible Tip Guard	2404548
GM 3600 Air Cap Assembly for Reversible Tip	394961
GM 3600 AirCoat Gun with Flat Tip Guard*	2412194
GM 3600 Air Cap Assembly for Flat Tip	394965
GM 3600 AirCoat Test Air Cap Kit	524229
GM 3600 AirCoat Gun, 50' Hose and Reversible Tip Kit	524219
GM 3600 AirCoat Gun, 50' Hose and Flat Tip Kit	524220

*Includes 9/20 Flat Tip.

BRILLIANT™ FLAT TIP SIZES (For GM 3600 Gun)				
DESIGNATION	ORIFICE DIAMETER	ANGLE	RECOMMENDED FILTER	PART NO.
9/20	0.009	20	180 Mesh	526209
9/40	0.009	40	180 Mesh	526409
11/10	0.011	10	180 or 100 Mesh	526111
11/20	0.011	20	180 or 100 Mesh	526211
11/40	0.011	40	180 or 100 Mesh	526411
13/10	0.013	10	100 Mesh	526113
13/20	0.013	20	100 Mesh	526213
13/40	0.013	40	100 Mesh	526413
15/10	0.015	10	100 Mesh	526115
15/20	0.015	20	100 or 50 Mesh	526215
15/40	0.015	40	100 or 50 Mesh	526415
17/20	0.017	20	50 Mesh	526217
17/40	0.017	40	50 Mesh	526417

M-4 and M-8 Mastic Guns

- ◆ Straight line fluid passage allows max flow rate
- ◆ Angled handle for increased comfort
- ◆ Adjustable needle packing prolongs the life of critical wear parts
- ◆ Swivel allows freedom of movement without hose kinking
- ◆ Lightweight metal construction

DESCRIPTION	psi	PART NO.
M-4 Mastic Gun (filter sold separately)	3600 (24.8 MPa)	289013
M-8 Mastic Gun (filter sold separately)	7700 (53.1 MPa)	289014
M-8 Mastic Gun with 3/8" Fitting (filter sold separately)	7700 (53.1 MPa)	2425442
M-4 / M-8 Repair Kit	---	2348175

For Textured Applications

Splatter Nozzle 765-360

Add the splatter nozzle to any airless spray gun for smooth texture applications including orange peel and knock down. For best results use with M Series Airless Guns.

Air requirement 4-12 CFM at full open.



GM 5000 Electrostatic Gun & Powerpack 521133

Up to 20% higher transfer efficiency than competitive electrostatic sprayers.

- ◆ High-voltage ON/OFF at the gun
- ◆ Automatic error indication
- ◆ Easy to adjust atomization and pattern shape
- ◆ Comes complete with gun, hose, round and flat tip
- ◆ Add electrostatic capability to any any solvent compatible airless sprayer





THE INDUSTRY LEADER IN TIP TECHNOLOGY

Airless spray tips are a key component to the successful operation of an airless spray system. They define the spray pattern, control the flow, atomize the coating and ultimately tell the pump how hard it must work. A proper understanding of airless tips is critical to the success of any airless application.

Tip Characteristics

It is important to remember that the orifice size, in conjunction with the fan-width, determines the spray characteristics of the tip.

Tip Wear

When beginning a project, choosing the right tip size and fan width will determine both coating consumption and production time. If the tip size is wrong — either by choice or through wear — mil thicknesses will be too heavy and the finish will be unprofessional.

The spray pattern chart demonstrates what happens as a tip wears. As wear occurs, the pattern size decreases and the orifice size increases. You will have to make more passes to cover the same area. There is no standard rate of tip wear due to the variation of the abrasiveness of all coatings.

Examples for Understanding Airless Tips

Example A:

The larger the orifice with the same fan width, the greater the volume of paint applied to the area.

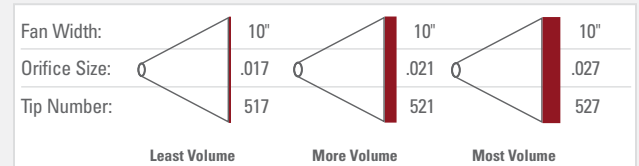

Example B:

The larger the fan width with the same orifice means the same amount of material is being applied over a greater area. The result is less volume of paint per square inch.

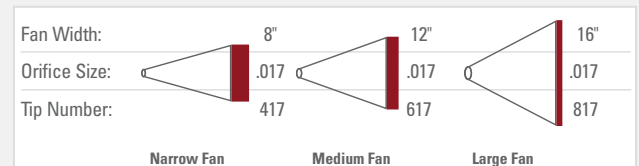

How a Tip Fan Pattern Typically Wears

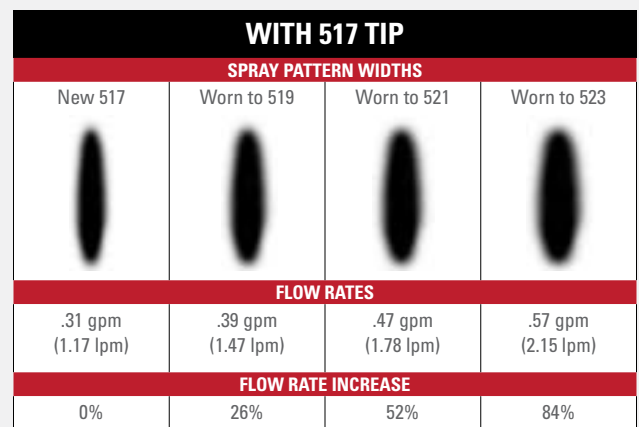
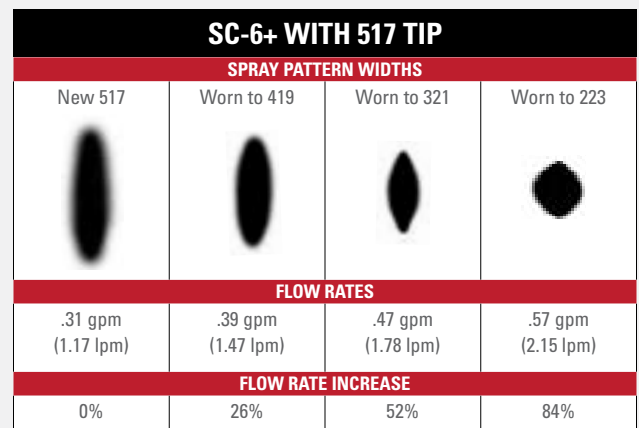

PREMIUM REVERSIBLE TIPS

- ▶ The best overall performing tip in the industry
- ▶ Fan pattern stays wider longer
- ▶ An orifice that outlasts competitive tips delivering consistent film thickness and less wasted paint
- ▶ Fits all Titan and most other industry spray gun guards

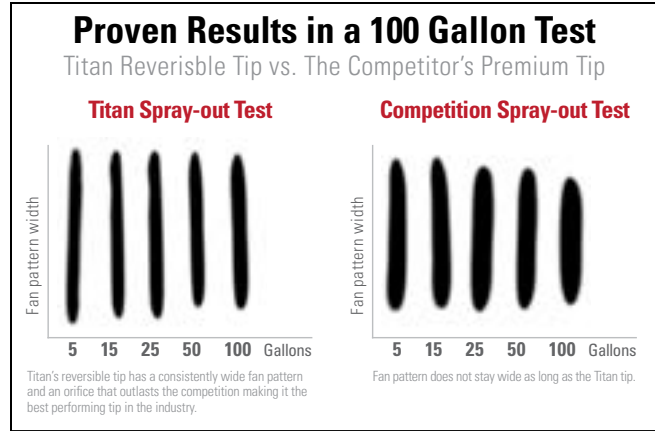

High Pressure Tips 696-XXX

		ORIFICE SIZE (INCHES)													
		0.011	0.013	0.015	0.017	0.019	0.021	0.023	0.025	0.027	0.031	0.035	0.037	0.039	0.043
FAN PATTERN WIDTH	4-6	211	213												
	6-8			315	317	319	321	323	325						
	8-10			415	417	419									
	10-12			515	517	519	521	523	525	527	531	535	537		543
	12-14									627					
	14-16						721								
	16-18											835		839	
	18-20							923							
Flow (gpm)	---	0.13	0.18	0.24	0.31	0.39	0.47	0.57	0.67	0.78	1.03	1.32	1.40	1.64	1.99
Flow (lpm)	---	0.45	0.68	0.91	1.17	1.47	1.78	2.15	2.53	2.95	3.89	4.99	5.29	6.20	7.52

Maximum Working Pressure: 7700 psi (53.1 MPa)



Line Striping Tips 697-XXX

		ORIFICE SIZE (INCHES)							
		0.013	0.015	0.017	0.019	0.021	0.023	0.025	0.027
FAN PATTERN WIDTH	2	215	217	219					
	4	413	415	417	419	421	423		427
	6	615	617	619	621				
	8-10				821	823			
	Flow (gpm)	---	0.18	0.24	0.31	0.39	0.47	0.57	0.67
Flow (lpm)	---	0.68	0.91	1.17	1.47	1.78	2.15	2.53	2.95

Maximum Working Pressure: 5000 psi (34.5 MPa)



Flow rates are calculated at 2000 psi with water.

HEA™

HIGH EFFICIENCY TIPS

Revolutionary Low Pressure Technology

- Optimized to spray all architectural paints and coatings at 1000 psi at production speed
- Decreases overspray up to 55% allowing contractors to spray more
- Less pressure equals less stress extending pump life and extending time between repacks
- Two times the life of a standard reversible tip
- Patented design



The Right Mix For Production 330-XXX

		ORIFICE SIZE (INCHES)						
	INCHES	MM	0.011	0.013	0.015	0.017	0.019	0.021
FAN PATTERN WIDTH	4-6	102-152	211	213				
	6-8	152-203	311	313				
	8-10	203-254	411	413	415	417		421
	10-12	254-305			515	517	519	521
	12-14	305-356			615	617	619	621
	Flow (gpm)	---	---	0.13	0.18	0.24	0.31	0.39
Flow (lpm)	---	---	0.34	0.45	0.68	0.91	1.17	1.79

Maximum Working Pressure: 5000 psi (34.5 MPa)

Flow rates are calculated at 2000 psi with water.



HIGHLY EFFICIENT FAN PATTERN



Latex paint through a standard 517 tip at 1,000 psi



Latex paint through a HEA 517 tip at 1,000 psi

- Feathered edge provides consistent coverage
- More forgiving pattern that decreases runs and drips
- Less kickback when triggered providing more control and less overspray
- Fits all industry standard guards

Maximize the Performance of your HEA Tip



HEA Gauge Assembly Kit 580495

HIGH QUALITY SC-6+ REVERSIBLE TIP

- The industry's longest-lasting orifice
- Up to 22% wider fan pattern
- Fits all Titan and most industry standard guards

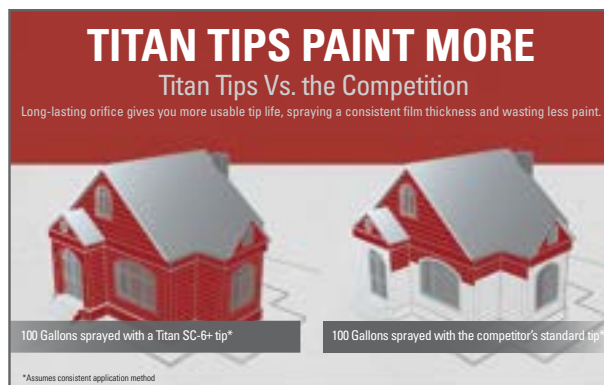

SC-6+ Tips 662-XXX

		ORIFICE WIDTH (INCHES)															
		INCHES	MM	0.007	0.009	0.011	0.013	0.015	0.017	0.019	0.021	0.023	0.025	0.027	0.029	0.031	0.035
FAN PATTERN WIDTH	4-6		102-152	207	209	211	213	215	217	219							
	6-8		152-203		309	311	313	315	317	319	321		325				
	8-10		203-254		409	411	413	415	417	419	421						
	10-12		254-305			511	513	515	517	519	521	523	525			531	535
	12-14		305-356		609	611	613	615	617	619	621	623	625	627	629	631	635
	Flow (gpm)		---	0.05	0.09	0.13	0.18	0.24	0.31	0.39	0.47	0.57	0.67	0.78	0.91	1.03	1.32
Flow (lpm)		---	0.19	0.34	0.45	0.68	0.91	1.17	1.47	1.78	2.15	2.53	2.95	3.44	3.89	4.99	



Maximum Working Pressure: 5000 psi (34.5 MPa)

SC-6+ Fine Finishing Tips 671-XXX

		ORIFICE SIZE (INCHES)					
		INCHES	MM	0.008	0.010	0.012	0.014
FAN PATTERN WIDTH	4-6		102-152	208	210	212	214
	6-8		152-203	308	310	312	314
	8-10		203-254	408	410	412	414
	10-12		254-305		510	512	514
	12-14		305-356			612	
	Flow (gpm)		---	0.07	0.11	0.16	0.21
Flow (lpm)		---	0.26	0.42	0.60	0.79	

Maximum Working Pressure: 5000 psi (34.5 MPa)



Flow rates are calculated at 2000 psi with water.

TIP & GUARD COMBO KITS

Includes tip guard, airless tip, saddle and white tip seal.



HEA Tip & Guard Combo Kit

- Optimized to spray all architectural paints and coatings at 1000 psi at production speed
- Decreases overspray up to 55% allowing contractors to spray more
- Less pressure equals less stress extending pump life and extending time between repacks

DESCRIPTION	PART NO.
411 HEA Tip and Guard Combo Pack	330-411G
515 HEA Tip and Guard Combo Pack	330-515G
517 HEA Tip and Guard Combo Pack	330-517G
621 HEA Tip and Guard Combo Pack	330-621G



SC-6+ Fine Finish Tip & Guard Combo Kit

- Ideal for lacquers, stains, enamels and clear coats
- Particle size up to 27% smaller than a standard tip
- Double orifice provides a soft spray pattern delivering a fine finish
- Extremely durable with the industry's longest lasting orifice.

DESCRIPTION	PART NO.
210 Fine Finish Tip and Guard Combo Pack	671-210G
310 Fine Finish Tip and Guard Combo Pack	671-310G
312 Fine Finish Tip and Guard Combo Pack	671-312G
408 Fine Finish Tip and Guard Combo Pack	671-408G

A GUARD FOR EVERY TIP

Titan tip guards are designed to maximize airflow with minimal overspray. With a guard for every tip and the universal fitting which matches most industry standard guns we have you covered.

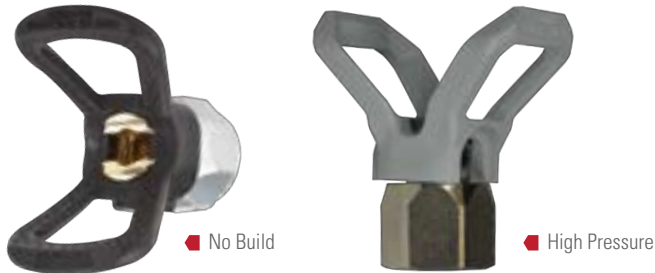

No Build Guard (7/8") 0289228A

Aerodynamic dimple design allows for better airflow and less paint build up. Seal cavity on safety guard has large "flats" for quick and easy installation of seal.

- ◆ Rotate guard without loosening from gun
- ◆ No tools needed for installation
- ◆ Interchangeable with most industry spray guns
- ◆ Pressure rated at 5000 psi (34.5 MPa)

High Pressure Tip Guard (7/8") 661-027

- ◆ Interchangeable with most industry spray guns
- ◆ Pressure rated at 7700 psi (53 MPa)

Flat Tip Guard

- ◆ Interchangeable with most industry spray guns
- ◆ Pressure rated at 5000 psi (53.1 MPa)

DESCRIPTION	PART NO.
7/8" (Flat tips only)	450-100A
11/16" (Flat tips only)	153003



Seals

DESCRIPTION	PART NO.
Metal Retainer ¹	297007
Black Seal, Latex ¹	651-042
White Seal, Solvent Resistant ¹	651-020
White Seal, Solvent Resistant (6-pack) ¹	661-021
Seal and Retainer Kit, Solvent Resistant (5-pack) ¹	661-020
Seal and Retainer Kit, Solvent Resistant (12-pack) ¹	651-060
Gasket Kit, 1/8" (12-pack) ²	711-612
Gasket Kit, 1/16" (12-pack) ²	711-606

¹ For use with No Build Guard and High Pressure Tip Guard.
² For use with Flat and Adjustable Tip Guard



THE BEST FILTERS AVAILABLE

Nothing destroys a piston or a gun tip faster than debris in the coating. That's why you need the best paint filters available. Titan gun filters and manifold filters are designed for long life and maximum protection. They are made from stainless steel for strength and service. We offer a wide variety of mesh sizes from 0 to 150.

Gun and Pump Filters

Unthreaded filter design for quick and easy replacement.

For use with RX-Pro®, RX-80™, G-10, LX-30, LX-40, LX-50, LX-75, S-3 and S-7.

UNTHREADED		
FILTERS	BULK PART NO.	2-PACK PART NO.
Coarse (Green)*	581-059	89957
Medium (White)	581-060	0089958B
Fine (Yellow)	581-062	0089959A
Extra Fine (Red)	581-061	89960

*Manifold filter for Impact 410.



Unthreaded filters

For use with LX-80^{II} and LX-80 Platinum.

THREADED		
FILTERS	BULK PART NO.	2-PACK PART NO.
Coarse (Green)	540-030	500-200-03
Medium (White)	540-060	500-200-06
Fine (Yellow)	540-100	500-200-10
Extra Fine (Red)	540-150	500-200-15

Pump Manifold Filter Plugs



MESH	PART NO.
Impact 400, 410	532357
Impact 440, 540, 640	552934
Impact 740 –1140 and 1200SF	558668

Pump Manifold Filters

For use on Impact X™ 410, X 440, and X 540i

BULK	
MESH	PART NO.
Coarse-30 Mesh	2426268
Medium-60 Mesh	2424933
Fine-100 Mesh	2426269
PACKAGED	
MESH	PART NO.
Coarse-30 Mesh	2440407
Medium-60 Mesh	2440406
Fine-100 Mesh	2440408

For use on Impact® 440–1140i & IA and Elite 3500.

MESH	PART NO.
Coarse-30 Mesh	730-067-30
Medium-60 Mesh	730-067
Fine-100 Mesh	730-067-10

For use on PowrTwin™ 4900, 6900, 8900 and 12000 Plus. PowrBeast™ 4700, 7700, and 9700

MESH	PART NO.
Mastic-0 Mesh	930-004
Coarse-5 Mesh	930-005
Medium-50 Mesh*	930-006
Fine-100 Mesh	930-007

*Standard with sprayer. Includes ball.

For use on PowrCoat 7", 9" and 10" models.

MESH	PART NO.
10" Filter Support	533515
Coarse-5 Mesh	920-001
Medium-50 Mesh*	920-004
Fine-100 Mesh	920-005
60 Mesh (PowrCoat 10")	533514

* Standard with sprayer, excludes ball. Ball check sold separately (920-103).



Pump Manifold Filters

Inlet Screens

Inlet Screens

SMALL		
MESH	BULK PART NO.	PACKAGED PART NO.
30 mesh (Fine)	700-900	700-900A
10 mesh (Coarse)	700-805	700-805A
30 mesh	----	552947*

*For PowrLiner 550 and 850 only

LARGE		
MESH	BULK PART NO.	PACKAGED PART NO.
30 mesh (Fine)	710-191	710-191A
10 mesh (Coarse)	710-046	710-046B

HYDRAULIC AND PNEUMATIC DESCRIPTION		PART NO.
PowrTwin 4900, 6900, 8900, 12000 Plus and XLT		0509762A
All GHD		710-046A
Hydra Pro IV		0509762A
PowrCoat 10" (30 Mesh)		533968

In-Line Filter 550-223

Designed for added filtration or when using a gun without a filter.



In-line Gun Filter

WHEN YOUR ARMS JUST AREN'T LONG ENOUGH

Our aluminum gun extensions are lightweight and easy to handle and can be used with all 7/8" thread airless spray guns.

- ▶ Pressure rated at 3600 psi (24.8 MPa).

Packaged Extensions

DESCRIPTION	PART NO.
5" Gun Extension	2418848
10" Gun Extension	2418850
20" Gun Extension	2418851
30" Gun Extension	2418852

Bulk Extensions with Tip Guard

DESCRIPTION	PART NO.
5" Gun Extension	2418843
10" Gun Extension	2418845
20" Gun Extension	2418846
30" Gun Extension	2418847

Bulk Extensions

DESCRIPTION	PART NO.
Bulk 5" Gun Extension	2418836
Bulk 10" Gun Extension	2418839
Bulk 20" Gun Extension	2418840
Bulk 30" Gun Extension	2418841



High Pressure, Alloy Steel Gun Extensions

When you need something a little more heavy duty. Can be used with all 7/8" thread airless spray guns.

- ▶ Pressure rated at 7700 psi (53.1 MPa).

DESCRIPTION	PART NO.
10"	2442148
20"	2442149
30"	2442150

7/8" x 14 thread is standard.



▶ Packaged



▶ Bulk with Tip Guard



▶ Bulk



SprayGuide™

May your lines be straighter and your profits greater! This unique free-wheeling disc glides smoothly over virtually every surface.

Cut-in around windows, doors, trim and more without time-consuming prep work.

- ▶ Eliminates time-consuming masking or cutting in with brush
- ▶ Attaches to a gun extension or an extension pole (sold separately) decreasing ladder work
- ▶ Best if used with a 411 tip (not included)
- ▶ Pressure rated at 3600 psi (24.8 MPa)

DESCRIPTION	PART NO.
SprayGuide Complete Kit	538900
SprayGuide Replacement Arm and Disk Only	538902



Swivel Head 538029

Titan's new easy turn swivel rotates 260 degrees for greater versatility and accessibility.

- Pressure rated at 3600 psi (24.8 MPa)

DESCRIPTION	PART NO.
7/8" x 14 Thread Swivel Head - Female	538029
7/8" x 14 Thread Swivel Head - Male	711-600



Extension Pole

These lightweight aluminum extensions are constructed with inner core ribs which reinforce the poles and greatly increase their rigidity. The inner core rib construction allows different length poles to be easily coupled together up to 12', while maintaining the proper rigidity to suit most job conditions.

- Reach high out-of-the-way places when spray or pressure rolling
- Adapts to most airless guns
- Pressure rated at 3600 psi (24.8 MPa)

DESCRIPTION	PART NO.
3' (0.9 m) Pole with Guard Packaged	2418862
6' (1.8 m) Pole with Guard Packaged	2418863
3' Extension Pole with Swivel	2437218
6' Extension Pole with Swivel	2437221
3' Pole (Bulk)	2418857
6' Pole (Bulk)	2418858

LX-75 In-Line Gun 550-475

- All metal construction
- A natural extension to any pole
- In-handle filter
- Swivel reduces hose kinks and ensures effortless control
- Pressure rated at 3600 psi (24.8 MPa)

Repair Kit (550-521)



6' Outrigger 757-920

Convert existing gun to 6' (2 m) pole gun and back in seconds. Outrigger allows you to increase production and profits. No additional hoses or fittings required.

- Constructed of lightweight and rigid aluminum to reduce arm fatigue
- Large gun installation holder and knob
- Adapts to all Titan airless spray guns and most manufacturers' airless spray guns

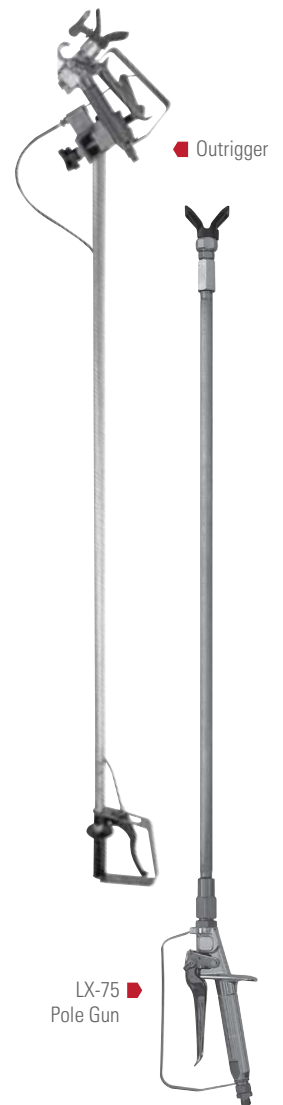

LX-75 Pole Gun 550-495

Reach those high, out-of-the-way places that normally require the use of a ladder or scaffolding.

- 4' in length. All metal construction
- Full-length needle ensures positive shut-off at tip
- Gun swivel
- In-handle filter
- Ergonomic design
- Pressure rated at 3600 psi (24.8 MPa)

Repair Kit (550-518)

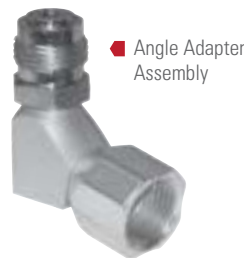

Angle Adapter Assembly



Extension Pole Coupling

Angle Adapter Assembly 509907

Adapt any extension pole to any standard airless gun. Because of its right-angle design, the angle adapter allows the pole to extend from the gun at the same angle as the handle. The result is greater efficiency and comfort.

- Pressure rated at 3600 psi (24.8 MPa)

Extension Pole Coupling 509908

Allows you to connect different length extruded poles together to create various lengths for any application. (Do not exceed 12')

PRODUCTIVE BACKROLLING



SPRAYROLLER™ DO TWO JOBS AT ONCE



SprayRoller Head with Tip

- ▶ Designed to spray and back roll in one motion
 - One person doing the work of two employees
- ▶ Reduces overspray decreasing Prep work
- ▶ Professional finish from a new/novice applicator
- ▶ Provides consistent mil thickness on textured surfaces
- ▶ Gives a roller finish; easier to touch-up
- ▶ Attaches to the Titan SprayGuide swivel
- ▶ Uses any standard roller cover
- ▶ Designed to be used with all airless sprayers and extension poles

- ▶ Quick tool-free changeover for the complete wall system

SPRAYGUIDE™ EXCLUSIVE CUT-IN TOOL

- ▶ No more taping, no more ladders
- ▶ Perfect for windows, doors and roof lines



DESCRIPTION	PART NO.
SprayRoller (no tip)	2403780
SprayRoller Combo Kit*	2403959
SprayRoller Combo Kit* with 3' Pole	2404013

*Combo Kit includes:
9" SprayRoller, SprayGuide, TR¹ 415 Reversible Tip & Swivel Head Assembly

INNER-FEED ROLLER™ ROLL NON-STOP UNTIL THE JOB IS FINISHED

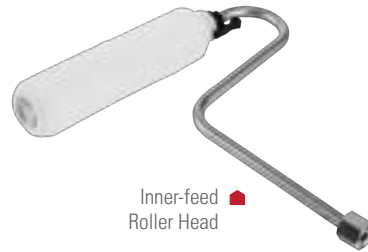

Inner-feed Roller Head

- ▶ Up to four times faster than standard rolling
- ▶ Never take the roller off the wall to go back to the tray; when the roller starts to get dry, simply pull the trigger to wet roller cover
- ▶ Never have to worry about dry edges
- ▶ More consistent mil thickness
- ▶ Designed to be used with all airless sprayers and any brand of extension pole

DESCRIPTION	PART NO.
Inner-feed Roller Head	2404445
Seal and O-Ring	514112
Roller Core w/Cap	514118

INNER-FEED ROLLER REPLACEMENT COVERS

- ▶ Perforated high-density knit polyester roller cover
- ▶ Distributes paint evenly for a smooth finish

DESCRIPTION	NAP	PART NO.
9" (23 cm)	3/4" (1.90 cm)	0155208E
9" (23 cm)	3/8" (0.95 cm)	0155206D

FULL FLUID SECTION ASSEMBLIES THAT KEEP YOU ON THE JOB.



Impact X

DESCRIPTION	PART NO.
Impact X™ 410 Skid	0532921A
Impact X 410 High Rider	2430171A
Impact X 440 (Skid/High Rider)	2440559
Impact X 540i (Skid/Low Rider/High Rider)	2456446

Impact & MultiFinish

DESCRIPTION	PART NO.
Impact® 400 Skid	0532921A
Impact 400 High Rider	0532922A
Impact 410 Skid	0532467A
Impact 410 High Rider	0532468A
Impact 440, 540, 640, & 640/1A (Skid/Low Rider)	805-207A
Impact 440, 540, 640, & 640/1A (High Rider)	805-233A
Impact 740, 840, & 840/1A (All Models)	805-236A
Impact 1040	0552603A
Impact 1140 & 1140/1A (High Rider)	805-246A
Impact 1040T	0532437A
Impact 1640	0558358A
MultiFinish™ 440	805-207A

Elite Series Repair Kits

DESCRIPTION	PART NO.
Elite® 3000, 3500	537903

PowrBeast Series

DESCRIPTION	PART NO.
PowrBeast® 4700	537255
PowrBeast 4700T	537268
PowrBeast 7700, 9700	537256

PowrTwin & Hydra Series

DESCRIPTION	PART NO.
PowrTwin™ 4900 Plus (All Models)	107-005
PowrTwin 6900 Plus (All Models)	236-005
PowrTwin 6900 Plus DI (All Models)	451-210
PowrTwin 8900 Plus, 12000 Plus (All Models)	236-015
PowrTwin 12000 Plus DI (All Models)	236-024
Hydra™ Pro IV	185-551A
Hydra X 7230 Fluid Section Only	2403440A
Hydra X 4540 Fluid Section Only	2401635A

PowrLiner Series Repair Kits

DESCRIPTION	PART NO.
PowrLiner™ 2850	0290513A
PowrLiner 3500	537903
PowrLiner 4500	2419852
PowrLiner 4950/4955 (All Models)	107-005
PowrLiner 6950/6955 (All Models)	236-005
PowrLiner 8950/8955 (All Models)	236-015

PowrCoat Series

DESCRIPTION	PART NO.
PowrCoat™ 730, 940	185-551A
PowrCoat 745, 960	155-559A
PowrCoat 975	533908
PowrCoat 1045	533262
PowrCoat 1064	533263
PowrCoat 1072	533264

THE RIGHT EQUIPMENT FOR THE JOB



High Quality Airless Fluid Hoses and Whip Hoses

I.D.	LENGTH		MAX. WORKING PRESSURE - psi (MPa)					END CONNECTION
			3300 (22.8)	3600 (24.8)	4500 (31.0)	6500 (44.8)	7500 (51.7)	
	FEET	METERS	PART NO.	PART NO.	PART NO.	PART NO.	PART NO.	
1/8"	3	0.9	---	---	290685	---	---	1/4" NPSM (F/M)
	3	0.9	291004	---	---	---	---	1/4" NPSM (F/M)
3/16"	5	1.5	316-506	---	---	---	---	1/4" NPSM (F/M)
	9	2.7	550-222	---	---	---	---	1/4" NPSM (F/M)
	25	7.6	291007	---	---	---	---	1/4" NPSM (FBE)
	50	15.2	291008	---	---	---	---	1/4" NPSM (FBE)
	3	0.9	---	---	2389428	2389440	2389450	1/4" NPSM (FBE)
1/4"	6	1.8	316-533*	---	2389430	2389442	2389452	1/4" NPSM (FBE)
	6	1.8	550-227	---	---	---	---	1/4" NPSM (FBE)
	12	3.7	2408659	---	---	---	---	1/4" NPSM (FBE)
	25	7.6	316-513	---	---	---	---	1/4" NPSM (FBE)
	50	15.2	316-505	286498	2389429	2389441	2389451	1/4" NPSM (FBE)
	100	30.5	---	---	2389427	2389439	2389449	1/4" NPSM (FBE)
3/8"	6	1.8	---	---	2389436	2389446	2389456	3/8" NPSM (FBE)
	25	7.6	508342	---	---	---	---	3/8" NPSM (FBE)
	50	15.2	291006	286499	2389434	2389445	2389455	3/8" NPSM (FBE)
	100	30.5	---	---	2389432	2389444	2389453	3/8" NPSM (FBE)
1/2"	25	7.6	225-112*	---	---	---	---	1/2" NPSM (FBE)
	50	15.2	250-112*	---	2389425	2389438	2389448	1/2" NPSM (FBE)
	100	30.5	---	---	2389424	2389437	2389447	1/2" NPSM (FBE)
3/4"	50	15.2	---	---	---	2389443	2426010	3/4" NPSM (FBE)

*Textile Braid. Spring guards at both ends.

FBE Female Both Ends, NPT National Pipe Tapered Thread, NPSM National Pipe Straight Mechanical Thread, MBE Male Both Ends, F/M 1 Female / 1 Male Connection

Moisture Resistant Hose

DESCRIPTION	PART NO.
3/8" x 7500 psi x 50'	375750050ML
1/2" x 7500 psi x 50'	500750050ML
3/4" x 1000 psi x 12' Transfer Hose	750100012R
3/4" x 7500 psi x 50' Transfer Hose	2426011



Hose Shield 521424

Protect your airless hose from paint and abrasion damage with a durable four-mil poly hose cover. Comes in 750' lengths. Works with 1/4" and 3/8" hoses.



Hose sold separately.



Reel-EZ Hose Reels

Eliminate hose hassles while increasing your production. Both models mount to most major manufacturers' paint sprayers with similar designs.

- ▶ 16" Cart-Mount holds up to 100' (30.5 m) of 1/4" airless hose
- ▶ 10" Skid-Mount holds up to 50' (15.2 m) of 1/4" airless hose
- ▶ Pressure rated at 3600 psi (24.8 MPa)

Fits handles/carts 3/4" to 1-1/2" in diameter.

DESCRIPTION	PART NO.
16" Cart-Mount	769-100
10" Skid-Mount	769-200



High Pressure Swivels

- ▶ Decreases resistance while spraying reducing overall fatigue
- ▶ Reduces hose kinking
- ▶ Pressure rated at 5000 psi (34.5 MPa)

DESCRIPTION	PART NO.
Gun-to-Hose / Hose-to-Pump 1/4" (0.63 cm) NPS (F) x 1/4" (0.63 cm) NPS (M)	509985
Hose-to-Hose 1/4" (0.63 cm) NPS (M) x 1/4" (0.63 cm) NPS (M)	502135

Air Spray Hoses

- ▶ Pressure rated at 100 psi (0.69 MPa)

DESCRIPTION	PART NO.
30' x 3/8" Air (Red)	295689
30' x 3/8" Fluid (Black)	277348

Air-Assisted Airless Spray Hoses

- ▶ Pressure rated at 3300 psi (22.8 MPa)

DESCRIPTION	PART NO.
1/4" x 25' Bonded Fluid Hose	9984595
1/4" x 50' Bonded Fluid Hose	524333
5' Fluid Whip Hose	550861



High Pressure Fluid Gauge Kit 508239

Includes: 5000 psi (34.5 MPa) high pressure fluid gauge attached to a T-Fitting with one 1/4" (M)(.63cm) fitting & one 1/4" (F)(.63cm) fitting.

Fluid Gauge Only (508626)



HEA Pressure Gauge 580495

Maximize the performance of your HEA Tips.



55 Gallon Impact Siphon Set 710-218

- ▶ Attaches to Impact 740 to 1140
- ▶ Longer siphon hose and return tube that allows customers to siphon material directly from a 55 gallon drum
- ▶ Increase productivity and limit bucket changeover



1 Gallon Impact Hopper Kit 704-453

- ▶ Attaches to Impact X 410 to 540; Impact 440 to 640 skid.
- ▶ Ideal for small applications or fine finish work
- ▶ Quick, easy clean-up



A FITTING FOR EVERY JOB

Spraying is more than just hooking up a hose. Sometimes the situation calls for extending hose length or altering the angle of the hose connected to the sprayer. That's when you need Titan manifolds and fittings. Our fittings are manufactured from quality carbon steel and plated for maximum corrosion resistance.

Couplings

HOSE TO HOSE		
DESCRIPTION	BULK PART NO.	PACKAGED PART NO.
1/4" NPT(M) x 1/4" NPT(M)	5045	0550063A
1/4" NPT(M) x 3/8" NPT(M)	812-003	0550064A
3/8" NPT(M) x 3/8" NPT(M)	490-014	550066
1/2" NPT(M) x 1/2" NPS(M)	449-621	-----

Maximum Working Pressure: 5000 psi (34.5 MPa)



HIGH PRESSURE HOSE TO HOSE	
DESCRIPTION	PART NO.
1/4" x 1/4" NPSM	367560
1/4" x 3/8" NPSM	367561
3/8" NPTF (M) x 3/8" NPTF(M)	9885643
3/8" NPTF (M) x 1/4" NPTF(M)	9885646
1/2" NPTF (M) x 1/4" NPTF(M)	9885644
1/2" NPTF (M) x 3/8" NPTF(M)	9885647
1/2" NPTF (M) x 1/2" NPTF(M)	9885648
3/4" x 1/2" NPSM	9985782
3/4" x 3/4" NPSM	9985781
3/4" x 3/8" NPSM	9985783

Maximum Working Pressure: 7500 psi (51.7 MPa)



MANIFOLD TO MANIFOLD	
DESCRIPTION	PART NO.
1/4" NPT(M) x 1/4" NPT(M)	490-002
1/4" NPT(M) x 3/8" NPT(M)	490-006
3/8" NPT(M) x 3/8" NPT(M)	814-004
3/8" NPT(M) x 1/2" NPT(M)	814-005
1/2" NPT(M) x 1/2" NPT(M)	814-006
3/4" NPT(M) x 3/4" NPT(M)	814-007

Maximum Working Pressure: 5000 psi (34.5 MPa)



MANIFOLD TO HOSE	
DESCRIPTION	PART NO.
1/4" NPT(M) x 1/4" NPS(M)	227-006
1/4" NPT(M) x 3/8" NPS(M)	804-555
1/4" NPT(M) x 1/2" NPS(M)	814-003
3/8" NPT(M) x 1/4" NPS(M)	812-003
3/8" NPT(M) x 3/8" NPS(M)	808-555
3/8" NPT(M) x 1/2" NPS(M)	815-005
1/2" NPT(M) x 1/2" NPS(M)	228-002

Maximum Working Pressure: 5000 psi (34.5 MPa)



90° Street Elbows

DESCRIPTION	PART NO.
3/8" NPT(F) x 3/8" NPT(M)	818-002
1/2" NPT(F) x 1/2" NPT(M)	9885613
3/4" NPT(F) x 3/4" NPT(M)	818-010

Maximum Working Pressure: 5000 psi (34.5 MPa)



Reducer Bushings

DESCRIPTION	PART NO.
3/8" NPT(M) x 1/4" NPT(F)	817-001
1/2" NPT(M) x 1/4" NPT(F)	929-061
1/2" NPT(M) x 3/8" NPT(F)	541-009
3/4" NPT(M) x 1/4" NPT(F)	929-062
1" NPT(M) x 3/4" NPT(F)	929-076
1-1/4" NPT(M) x 1" NPT(F)	929-077

Maximum Working Pressure: 5000 psi (34.5 MPa)



Pipe Tees

DESCRIPTION	PART NO.
1/4" NPT(F)	970-023
3/8" NPT(F)	817-002
1/2" NPT(F)	817-003
3/4" NPT(F)	817-004

Maximum Working Pressure: 5000 psi (34.5 MPa)



Swivel Unions

DESCRIPTION	PART NO.
1/4" NPS(F) x 1/4" NPT(M)	490-005
3/8" NPS(F) x 1/4" NPT(M)	490-042
1/4" NPS(F) x 3/8" NPT(M)	490-032
3/8" NPS(F) x 3/8" NPT(M)	490-043
1/2" NPS(F) x 1/2" NPT(M)	200-555
3/4" NPS(F) x 3/4" NPT(M)	138-037
1" NPS(F) x 1" NPT(M)	200-556

Maximum Working Pressure: 5000 psi (34.5 MPa)



Pipe Plugs

DESCRIPTION	PART NO.
1/4" NPT(M)	227-027
3/8" NPT(M)	227-033
3/4" NPT(M)	210-038

Maximum Working Pressure: 5000 psi (34.5 MPa)



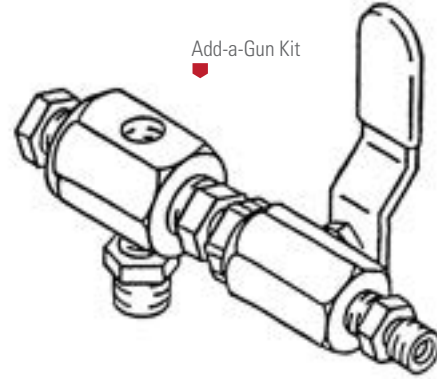
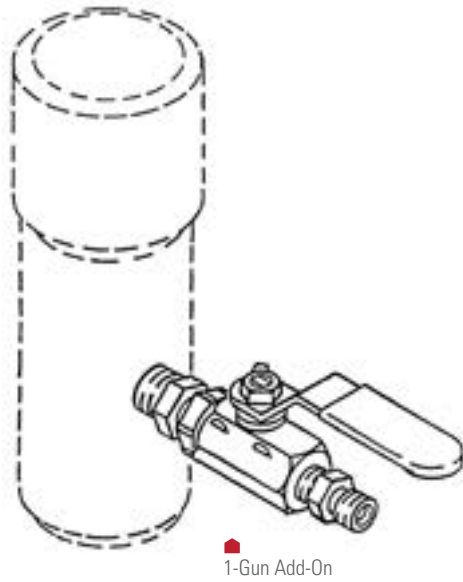

Gun Add-On Kits:

Can be used on pumps with an open 3/8" NPT port on the manifold.

	1-GUN ADD-ON		ADD-A-GUN	
	975-111 1/4" Hose	975-311 3/8" Hose	975-200 1/4" Hose	975-300 3/8" Hose
INCLUDES	PART NO.	PART NO.	PART NO.	PART NO.
Nipple, Hex	814-002	814-004	814-002	814-004
Ball Valve	940-553	941-555	940-553	941-555
Nipple, Hex	227-006	808-555	227-006	808-555
Plug, Pipe			227-033	227-033
Block, Manifold			970-100	970-100
Nipple, Hex			814-004	814-004

Maximum Working Pressure: 3600 psi (24.8 MPa)

Multiple Gun Add-on Assemblies (1/4")

Hose connection 1/4" MPSM (M).

	975-212 2-Guns
INCLUDES	QTY.
1-Gun Add-On (975-111)	1
Add-A-Gun Kit (975-200)	1
7500 psi Multi-Gun Manifold Kit (2414176)	1

Maximum Working Pressure: 3600 psi (24.8 MPa)

Multiple Gun Add-on Assemblies (3/8")

Hose connection 3/8" NPSM (M).

	975-312 2-Guns	975-313 3-Guns	975-314 4-Guns
INCLUDES	QTY.	QTY.	QTY.
1-Gun Add-On (975-311)	1	1	1
Add-A-Gun Kit (975-300)	1	2	3
7500 psi 3/4" 3-Gun Manifold (2414176)	1	2	3

Maximum Working Pressure: 3600 psi (24.8 MPa)

High Pressure Ball Valve

FITTING SIZE	psi	PART NO.
1/4"	6000 (41.4 MPa)	533358
1/4"	7500 (51.7 MPa)	533348
3/8"	6000 (41.4 MPa)	533359
3/8"	7500 (51.7 MPa)	533347

Maximum Working Pressure: 3000 psi (20.7 MPa)

HARD WORKING LINE STRIPER ACCESSORIES



■ LazyLiner Pro

■ LazyLiner Elite

LazyLiner™ Series

- Line Striper Hitch Kit required and sold separately
- Compatible with PL2850, PL3500, PL3500S, PL4500, PL4900XLT, PL4950, PL4955, PL6900XLT, PL6950, PL6955, PL8900XLT, PL8950, PL8955

	LAZYLINER PRO	LAZYLINER ELITE
DESCRIPTION		
Part Number	0290041H	0290040H
Gas Engine	Honda GX160	Honda GX200
Start	Pull	Electric
Forward Speed	0 - 12 mph (0 - 19 kph)	0 - 12 mph (0 - 19 kph)
Reverse Speed	0 - 7 mph (0 - 11 kph)	0 - 7 mph (0 - 11 kph)
Pneumatic Tires	Standard (16" x 4.5")	Heavy-Duty (16" x 6.5")
Bumper / Engine Protection Bar	Optional: Part No. 2423493	Included

LazyLiner Tray

- Carry additional items in this attachable tray
- For use on the LazyLiner Pro and Elite



	LAZYLINER PRO	LAZYLINER ELITE
ENGINE MODEL		
Honda	2423493 (Bumper) + 2413480 (Tray)	2413480
Subaru	0290646Z (Bumper) + 2413480 (Tray)	2413480

Hitch Kits

DESCRIPTION	KIT PART NO.
PowrLiner 2850	0290043Z
PowrLiner 3500, 3500S, 4500	537935
PowrLiner 4955, 6955, 8955	2430599
PowrLiner 4950, 6950, 8950	2430599
PowrLiner 4900XLT, 6900XLT, 8900XLT	+ 0290489A (updated axle with pre-drilled thru-holes)

LazyLiner drivers are not shipped with a hitch kit.



LineSite Laser Pointer



SureTrak Floating Gun Kit

LineSite™ Laser Pointer 0290175A

Great for start/stops, curb striping, executing perfectly straight lines and training new employees. High intensity green laser is easy to see in daylight.

SureTrak™ Floating Gun Kit 759-120

- Keep guns at same height above surface for perfect lines over rough terrain
- For PL4950, 4955, 6950, 6955, 8950, and 8955

TR² Line Striping Tips

From striping to stenciling – with the twist of the tip.



STRIPING TIP SIZE	STENCIL TIP SIZE	FLAG	FILTER COLOR	PART NO.
417	517	Yellow	White	694-1708517
419	519	Yellow	White	694-1908519
421	621	Yellow	White	694-2108621
423	623	Yellow	White	694-2308623

SideStriper® 759-150

- Stripes in tight spaces, including between vehicles
- Works with any airless striper



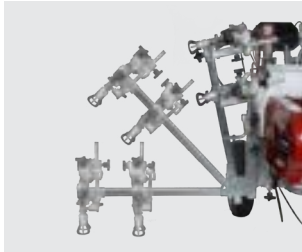

SmartArm Pivot System



SmartArm Lift System

SmartArm™ Assembly 290382

- Pivots and lifts, making line adjustments and transportation quick and easy
- Locks at any angle for efficient curb painting

Striper Add-On Accessories

RECOMMENDED GUNS		
DESCRIPTION	PART NO.	
LX-40 Gun	550-540	
RX-80 Gun	0538110A	
S-3 Gun	550060	
S-3 Gun Kit	759-138	
PowrLiner 2850 Gun Kit	290310	
PowrLiner 3500 Stencil Kit	2418165	

UPGRADES		
DESCRIPTION	PART NO.	
PowrLiner™ 850 Caster Release Kit	293970	
12-Gallon (45-liter) Hopper	759-130	
Polyethylene 5-Gallon Pail Cover	759-147	

WindGuard™ Spray Shield 290623

- Protects spray pattern from wind, minimizing overspray
- Adjustable width along with spring-loaded forgiveness on uneven surfaces



HandiBead™ Bead Dispenser 0290953A

- Apply glass beads with consistency and accuracy, eliminating hand tossing
- Adjustable dispersion width up to 15"



Stencil Kits

- Durable and lay flat for accurate marking
- Made from 1/8" (0.15 cm) thick polyethylene sheet



STENCIL KIT 1	
INCLUDES	PART NO.
39" (99 cm) Handicap	290932

STENCIL KIT 2	
INCLUDES	PART NO.
39" (99 cm) Handicap	290933
12" (30 cm) No Parking	
12" (30 cm) Numbers 0–9	

STENCIL KIT 3	
INCLUDES	PART NO.
42" (105 cm) Straight and Curved Arrows	290934
39" (99 cm) Handicap	
12" (30 cm) Numbers 0–9	
4", 12" (10, 30 cm) No Parking	
4", 12" (10, 30 cm) Fire Lane	
4" (10 cm) Reserved	
4" (10 cm) Visitors	



Glass Bead Dispensing Systems

DESCRIPTION	PART NO.
1-Gun Kit w/Hopper, 4-6" width	424-826
2-Gun Kit w/Hopper, 4-6" width	424-836
2nd Gun Kit, 4-6" width	424-816
1-Gun Kit w/Hopper, 12" width	424-840
2nd Gun Kit, 12" width	424-841
Bead Dispenser bracket kit <i>(only required for PowrLiner 3500, 3500S, and 4500)</i>	290181

Compatible Systems: PowrLiner 2850, 3500, 3500S, 4500, 4900XLT, 4950, 4955, 6900XLT, 6950, 6955, 8900XLT, 8950, 8955

TOOLS FOR THE PERFECT FINISH



Maxum Elite Gun



Maxum II Gun



Maxum Elite Gun with Gravity Cup and Stand

Maxum Elite Gun

For contractors and finishing professionals who expect flawless results with the versatility to use gravity- or siphon-fed cup gun.

- Removable and reversible fluid chamber design enables use with standard pressurized cup and pressurized gravity cup
- Stainless steel fluid passages
- Fluid needle stays with packing and head assembly for color and tip size changes—allows for easier storage and clean up
- Integrated check valve in gun head
- Patented grip design for stay-cool operation
- Multi-position pick-up tube for spraying at various angles
- Comes standard with a #3 Proset (Needle set)

DESCRIPTION	PART NO.
Maxum Elite Gun with 1 Qt. Cup	524027
Maxum Elite Gun with Gravity Cup	524052

MAXUM ELITE ACCESSORIES

DESCRIPTION	PART NO.
Pressure-Fed 1 Qt. Cup	0524271A
Front End Accessory with 1 Qt. Cup Assembly and #3 Proset	524073
Front End Accessory with 1 Qt. Cup Assembly and #4 Proset	524074
Gravity Cup Accessory with Stand	524045

Maxum II Gun

For maximum control and pinpoint-accurate coating delivery, the Maxum II is an excellent choice for contractors and finishing professionals who need a precise fine finishing tool.

- Ability to convert from non-bleeder to bleeder gun
- Comes standard with a #3 Proset (Needle set) and 1 Qt. cup

DESCRIPTION	PART NO.
Maxum II Gun with Pressure-Fed 1 Qt. Cup	524041

Projector Sets

DESCRIPTION	MAXUM II PART NO.	MAXUM ELITE PART NO.
#2 Proset (Fine Finish)	276254	524293
#3 Proset (All-Purpose)	276227	524294
#4 Proset (High Output)	276228	524295
#5 Proset (High Output)	276229	524296
#6 Proset (High Output)	276245	524297
#7 Proset (Highest Output)	524211	524298

Maxum II 
Standard Kit



Maintenance and Repair Kits

MAINTENANCE KITS			
DESCRIPTION	MAXUM II PART NO.	MAXUM ELITE PART NO.	
Deluxe Kit	279941	524189	
Standard Kit	279942	524188	

Gun Repair Kit 
for Maxum II Gun



GUN REPAIR KITS / PARTS		
DESCRIPTION		PART NO.
Replacement Check Valve Assemblies (three-pack)		297051
Check Valve Seals (10-Pack)		276257
Gun Repair Kit for Maxum II Gun		277943
Gun Repair Kit for Maxum Elite Gun		524187
Spring Plate Assembly		275250
Gun Repair Kit for 3100 Gun (Gravity Fed)		552916



REPLACEMENT TURBINE FILTERS

DESCRIPTION	PART NO.
Air Filter Kit (Pleated) Capspray™ 95, 105 and 115 Atomizing Air	0524523A
Air Filter Kit (Foam-Black) Capspray 75 Motor Cooling	0524258A
Air Filter Kit (Foam-Green) Capspray 75 Atomizing Air	529390
Pre-Filter Kit (Qty. 2) Capspray 55, 75, 95, 105 and 115	0524526A
CapSpray Filter Kit (Capspray 75)	275793
CapSpray Filter Kit (Capspray 95, 105, and 115)	275794

Accessories

CUPS AND ACCESSORIES

DESCRIPTION	PART NO.
1-Qt. Cup Assembly with Swivel Tube	277183
1-Qt. Replacement Cup	275573
2-Qt. Remote Cup System (Complete)	524203
Air-Tight Lid for Paint Cups (Keeps paint fresh for long periods)	508124
Cup Assembly without Swivel Tube	275247
600 ml HVLP Top Feed	524211
Gravity Cup Assembly with Stand	524045
White, 1 Qt. Cup Gaskets, Hot Solvents (6-pack)	297052
White, 2 Qt. Cup Gaskets, Hot Solvents	524337

White, 1 Qt. 
Cup Gaskets





Air Hoses and Fittings

DESCRIPTION	PART NO.
20' x 3/4" Flex Air Hose	275276
25' x 3/4" Flex Air Hose	275277
30' x 3/4" Flex Air Hose	277337
30' Air Hose	295689
5' x 3/4" Air Whip Hose	0524405A
30' x 3/8" Material Hose	277348
Quick Disconnect (F) Turbine	275625



HVLP Power Cart

A compact, lightweight solution to major application projects.

HVLP POWER CART & ACCESSORIES	
DESCRIPTION	PART NO.
HVLP Power Cart	524000
Pressure Pot Liner	275702
Pressure Pot Liner (12-Pack)	295272
Solvent Resistant Gasket	508943

2 Qt. Remote Cup 524203

Transform your turbine system into a high-capacity sprayer without adding the cost and weight of a bulky air compressor.

For use with all Capspray turbine sprayers.
5' Air whip hose sold separately.



Gun sold separately.



3M® PPS™ Paint Preparation System

3M PPS Paint Preparation System is a unique, closed paint system that eliminates the need for separate mixing cups and filters. Instead, paint is mixed in a liner bag which marries to a direct filter and is then mounted on the spray gun with a dedicated adapter.

- As freshly-filtered paint is dispensed, the liner bag collapses, allowing the spray gun to function at any angle.
- Liner bag and filter are disposable, leaving only the spray gun and adapter to be cleaned.
- 3M PPS Paint Preparation System is a cleaner, faster system, safe from outside contamination and offers considerable time and solvent savings on gun and parts cleaning.

DESCRIPTION	PART NO.
Series 2.0 3M PPS Starter kit (Cup, Gun Adapter and 10 lid and liners.)	CA91-589
Series 2.0 Pressure Cup	CA91-560
Series 2.0 Lids/Liners 10-pack	CA91-562
Series 2.0 PPS Adapter for Pressure Spray Gun	CA91-575

KEEP YOUR EQUIPMENT CLEAN AND WORKING FOR YOU

No matter what the sprayer – hydraulic, gear-driven, gas-powered or electric – if you want a long service life you will need to care for it with the same attention you care for your own car or truck. That means changing the oil, lubricating the piston, cleaning the unit, the gun and the tip. Titan has all the products you need to keep your accessories and equipment clean and functioning in top condition.

LS-10 Liquid Shield Plus™

Cleans and protects your spray system against rust and corrosion, extending the life of your pump.

- Includes anti-freeze protection to -32° C (-25° F)

DESCRIPTION	PART NO.
4 oz. Bottle	314-483
1 Qt. Bottle	314-482
1 Gallon Bottle	521418



Piston Lube™

Specially formulated to prevent materials from adhering to the piston rod.

- Proven to effectively reduce cylinder abrasion, piston wear
- Keep piston and packings properly lubricated for longer life

DESCRIPTION	PART NO.
4 oz. Bottle	314-481
8 oz. Bottle	314-480
1 Qt. Bottle	700-926
CAT Plasticizer (Recommended for use with silicone products)	91-36



Suitable for use with most airless piston pumps

PaintMate™

Water-based coating additive that significantly improves atomization with HVLP sprayers without compromising the integrity of the coating.

DESCRIPTION	PART NO.
1 Qt. Bottle	508071



AirCare™ 311-101

Pneumatic equipment lubricant storage protector. Contains premium additives to extend life of equipment. **1 Qt. Bottle**

Coolflo™

Hydraulic Fluid for PowrTwin™, Hydra™ and sealed hydraulic sprayers.

DESCRIPTION	PART NO.
1 Qt. Bottle	430-362
1 Gallon Bottle	430-361





WEARGUARD CONVENIENCE PROGRAM KEEPS YOU UP AND RUNNING

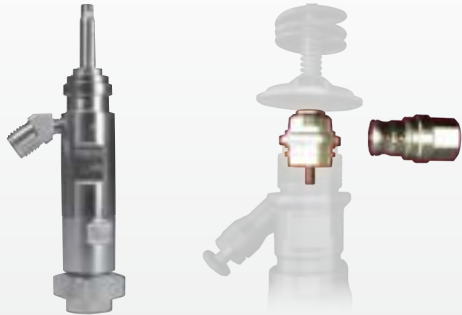

When you purchase a new Titan sprayer, you're able to take advantage of our exclusive WearGuard Convenience Program. Protect your investment by purchasing a spare fluid section or PermaStroke kit at a discounted rate. Save yourself the time and frustration of an extra trip or waiting for parts to arrive in the event that your sprayer goes down. When you have a backup fluid section or PermaStroke kit on hand, replacement can quickly be made without leaving the jobsite and doesn't require special tools. The bottom line is that WearGuard keeps you up and running.

Not interested in purchasing a spare fluid section? We also offer the option of a free packing kit on select sprayers.

For more information on pricing and how to order, go to:

www.titanwearguard.com
or scan the QR code.



KEEP TITAN WITH YOU WHEREVER YOU GO



MyTitan™ gives you immediate access to all things Titan. Anywhere, anytime on your computer or mobile device. MyTitan gives you everything you need to get the most out of your sprayers, all in one place, no matter where the workday takes you. MyTitan is designed to make your life easier, your business more efficient, and your day more productive—so you can stay ahead of the game, do more in less time, and never lose track of another detail.

For more information on this new app, go to:

www.titantool.com/mytitan-welcome
or scan the QR code.



THOR
TITAN HUB FOR ONLINE REDEMPTION

ONLINE REWARD REDEMPTION NO CLIPPING. NO STAMPS. NO HASSLES.

For more information and to see current promotions, go to:
www.titantool.com/thor-promos or scan the QR code.



All information contained in this brochure is based on the latest information available at the time of printing. Titan reserves the right to make changes at any time, without notice. Due to continuous innovation, specifications may progressively change. Contact one of our dependable sales reps or call our dedicated customer service team for more information.